

PLAN

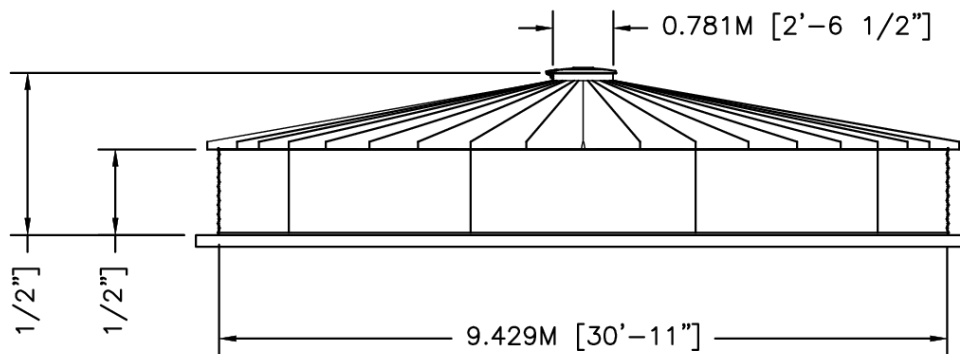

ELEVATION



	BY	DATE	TITLE	
DWN	XXX	XX/XX/XX	WTU10-01 30"PR 10DEG V-RIB	
CKD			NOMINAL CAPACITY - 68.285 M3 [18,039 GAL]	
ENG			DWG. NO. SCT3001-LVR WTU10-01	REV. NO.
SIZE:	A	SCALE:	1/8"=1'-0"	SHEET 1 OF 1